

Installing and Configuring the Dell™ Internal Wireless Card

Model 5002



www.dell.com | support.dell.com

Notes, Notices, and Cautions



NOTE: A NOTE indicates important information that helps you make better use of your computer.



NOTICE: A NOTICE indicates either potential damage to hardware or loss of data and tells you how to avoid the problem.



CAUTION: A CAUTION indicates a potential for property damage, personal injury, or death.

Information in this document is subject to change without notice.

© 2010 Dell Inc. All rights reserved.

Reproduction of these materials in any manner whatsoever without the written permission of Dell Inc. is strictly forbidden.

Trademarks used in this text: *Dell*, the *DELL* logo, *Inspiron*, *Dell Precision*, *Dimension*, *OptiPlex*, *Latitude*, *PowerEdge*, *PowerVault*, *PowerApp*, *Dell OpenManage* and the *YOURS IS HERE* logo are trademarks of Dell Inc.; *Intel*, *Pentium*, and *Celeron* are registered trademarks of Intel Corporation in the U.S. and other countries; *Microsoft*, *Windows*, *Windows Server*, *MS-DOS*, *Windows Vista* and *Windows 7* are either trademarks or registered trademarks of Microsoft Corporation in the United States and/or other countries.

Other trademarks and trade names may be used in this document to refer to either the entities claiming the marks and names or their products. Dell Inc. disclaims any proprietary interest in trademarks and trade names other than its own.

Contents

This guide can be used for Dell™ laser printers 5330dn, 2335dn, and 2355dn	4
About Notes and Cautions	4
Installing the Dell Internal Wireless Adapter Hardware	5
Configuring the Dell Internal Wireless Adapter	8
Appendix A. SetIP Address Utility	22
Appendix B. Management protocols	23
DHCP/BOOTP	23
HTTP	23
SNMP	24
SLP	25
Dynamic DNS (DDNS)	26
WINS	27
Bonjour	28
UPnP	28
Appendix C. Printing protocols	30
Standard TCP/IP port	30
LPR port	31
IPP port	32

Appendix D. Additional functions	34
Printer properties settings	34
Firmware upgrade (HTTP)	34
Default setting (HTTP/SNMP)	34
IP filtering	34
Restart	35
Ethernet speed	35
Appendix E. Netware environment	36
NetWare printing	36
Configuring NetWare	37
Printing in NetWare	39
Appendix F. EtherTalk environment	40
EtherTalk printing	40
Configuring EtherTalk	40
Configuring the printer	41
TCP/IP printing	42
Bonjour printer	43
Appendix G. Wireless network environment	45
Overview	45
Basic concept and terms	45
Network Status	50
Network setup	50
Security setup	51
Network Key Setup	52
802.1x Security Setup	52

Appendix H. Wireless Specifications	55
Appendix I. Regulatory statement	56
FCC Compliance	56
EU Compliance	58
Appendix J. OpenSSL License	62
Original SSLeay License	63

This guide can be used for Dell™ laser printers 5330dn, 2335dn, and 2355dn

About Notes and Cautions

 **NOTE:** A NOTE indicates important information that helps you make better use of your computer.

Contents

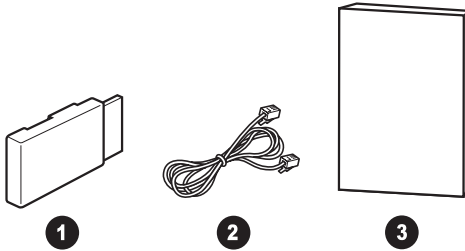

Callout	Item
1	Dell Internal Wireless Adapter
2	Ethernet cable
3	Installation Guide (This document)

 **NOTE:** In order to use the printer wirelessly you need to install and configure the Dell Internal Wireless Adapter.

Installing the Dell Internal Wireless Adapter Hardware

- 1 Ensure that the printer is turned off and the power cord is unplugged from the power source.

⚠ CAUTION: Failure to unplug the printer could cause damage to the printer.

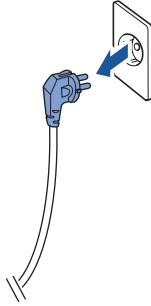

For Dell™ Mono 5330dn only,

Detach the dummy panel on the back of your printer using a firm object, such as a screwdriver.

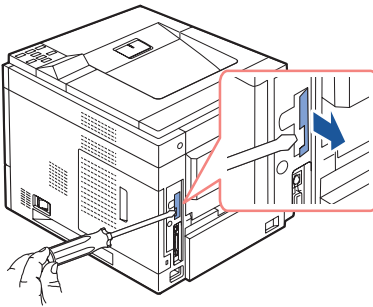

For Dell™ Mono Laser 5330dn

- 2 Slide the control board cover towards the back of the printer to open it.

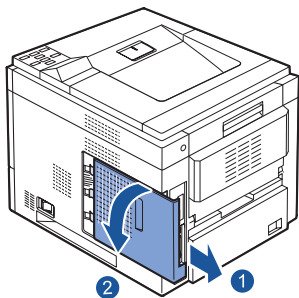

For Dell™ Mono Laser 5330dn

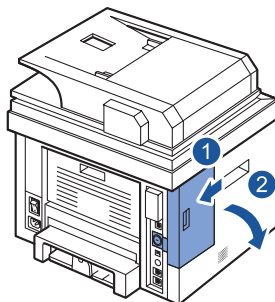

For Dell™ MFP Laser 2335dn and 2355dn

- 3 Locate the card connector on the printer's connector board.

wireless network connector

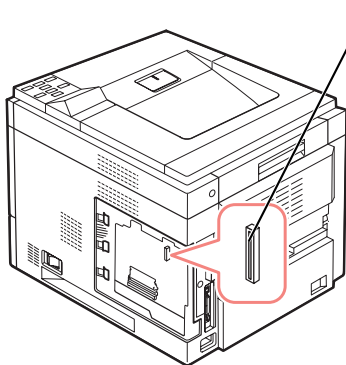

For Dell™ Mono Laser 5330dn

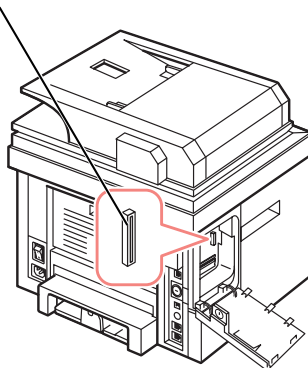

For Dell™ MFP Laser 2335dn and 2355dn

- Align and insert the Dell Internal Wireless Adapter into the connector on the control board. Push it into the connector until it is firm and secure.

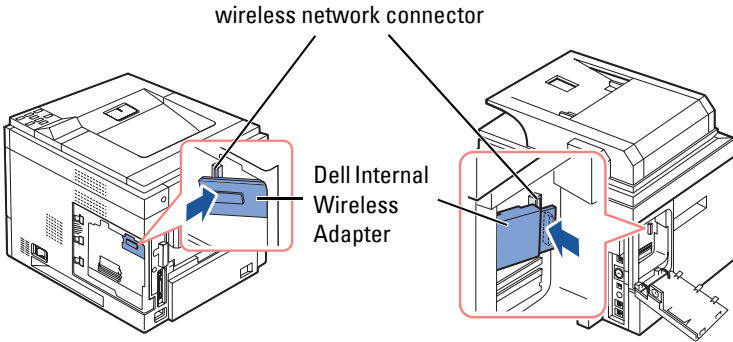

For Dell™ Mono Laser 5330dn

For Dell™ MFP Laser 2335dn and 2355dn

- Replace the control board cover.

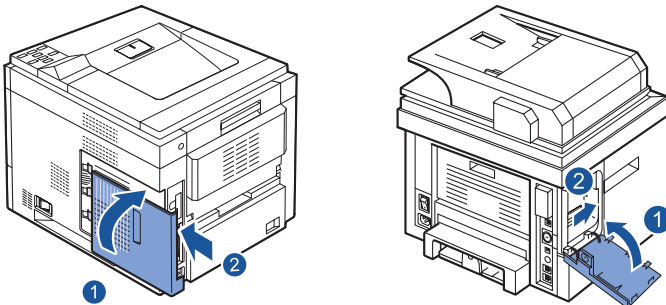

For Dell™ Mono Laser 5330dn

For Dell™ MFP Laser 2335dn and 2355dn

- Reconnect the power cable and all other disconnected cables. Turn on the printer.
- In order to use the printer wirelessly you need to install and configure the Dell Internal Wireless Adapter. See *"Configuring the Dell Internal Wireless Adapter"* on page 8 for instructions.

Configuring the Dell Internal Wireless Adapter

Before installing the printer's driver on your computer, you must configure the appropriate network parameters of the printer.



NOTE: The following network information may be needed to configure the Dell Internal Wireless Adapter on the printer.

- Network Name, also known as SSID (Service Set ID)
- Network authentication and encryption type
- Security Key(s) or Password

For more information, contact your wireless network administrator or see the provided pdf network documentation.

The Dell 2335dn, Dell 2355dn, and Dell 5330 supports two standard wireless operation modes, Infrastructure (recommended) & Ad hoc.

- **Infrastructure mode (recommended):** In Infrastructure mode, wireless devices or workstations communicate with each other through an access point (AP). In Infrastructure, wireless works after existing LAN cable connection to the printer is unplug. (i.e. un-plug LAN cable when using access point)
- **Ad hoc (peer-to-peer) mode:** Ad hoc mode is also referred to as Peer-to-Peer mode. In Ad hoc mode, printer communicates directly with other devices, without using an access point (AP). If wireless operation mode is ad-hoc, user can use the printer to print & share files both wireless as well as wired communication.

There are three ways the Dell Internal Wireless Adapter can be configured.

Either;

- **Method 1:** Using the printer's Operator Panel (recommended for simple network security such as WEP). *See page 10 for instructions.*
- **Method 2 (Dell 2355dn only):** Using the printer's Operator Panel (recommended for simple network such as Connection via PBC). *See page 10 for instructions.*

Or,

- **Method 3:** Assigning the printer an IP address, using the IP address to access the printer and using the printer's **Embedded Web Server**. *See page 15 for instructions.*

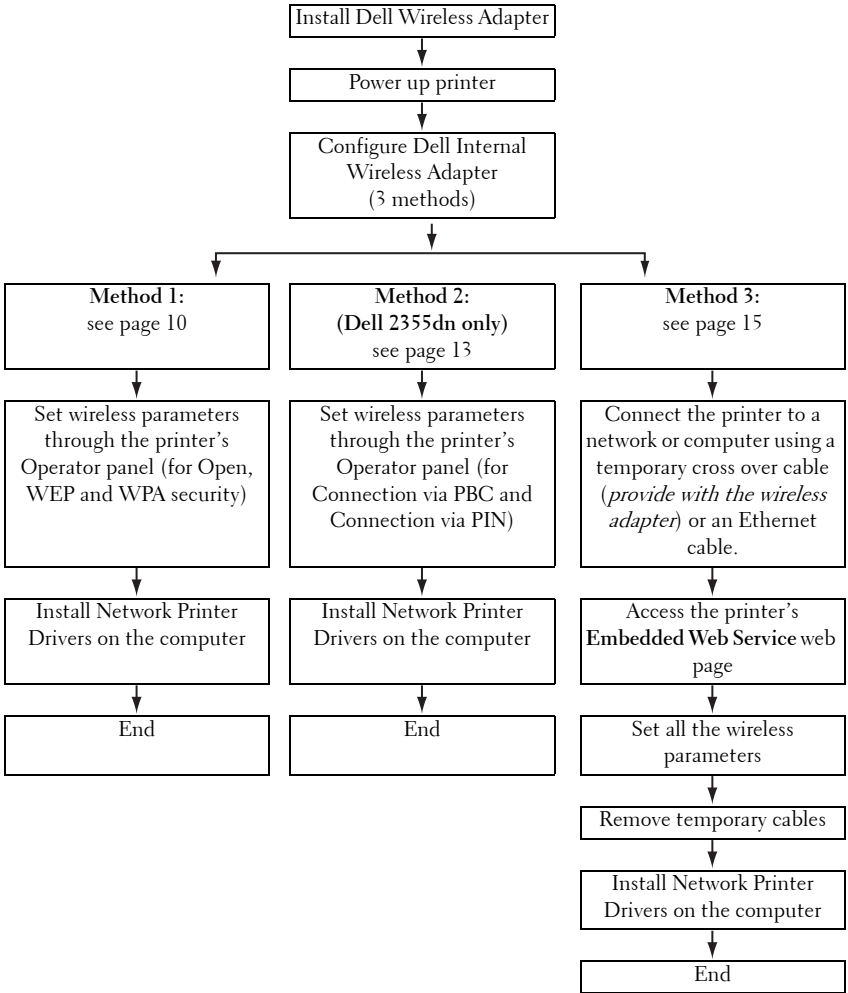

Method 1:

The Dell Internal Wireless Adapter can be configured at the printer's operator panel. This method only supports open network systems, WEP network security and WPA network security.

- 1 Navigate to the Wireless sub menu on the printer's Operator Panel

For Dell 5330dn Mono Laser:

- a Press **Menu** (☰).
- b Press **Scroll** (∧ or ∨) to highlight **Network I/O Ports** and press **Select** (✓).
- c Press **Scroll** (∧ or ∨) to highlight **Wireless** and press **Select** (✓).

For Dell 2335dn MFP:

- a On the main menu of the operator panel, scroll to **Setup** using **Scroll** (< or >) and press **Select** (✓).
- b On the **Setup** menu, scroll to **Network Setup** using **Scroll** (∧ or ∨) and press **Select** (✓).
- c On the **Network Setup** menu, scroll to **Wireless** using **Scroll** (∧ or ∨) and press **Select** (✓).

For Dell 2355dn Laser MFP:

- a Press **Setup** → **Machine Setup** from the home screen.
 - b Press the **Next** (▶) button.
 - c Press the up/down arrows to select **Network Setup**.
 - d Press the up/down arrows to select **Wireless**.
- 2 Press **Scroll** (∧ or ∨) to highlight **WLAN Settings** and press **Select** (✓).

For Dell 2355dn Laser MFP:

Press **WLAN Settings**.

- 3 Configure the Dell Internal Wireless Adapter based on your wireless network and network security requirements.

This method supports two modes.

Either;

- **Search List:** Automatically displays a list of available networks and prompts for the security key (if applicable).

Or,

- **Custom:** Allows users to enter a SSID and set the security mode and key manually.

Below are the first screens you may encounter.

For Dell 5330dn Mono Laser and Dell 2335dn MFP:

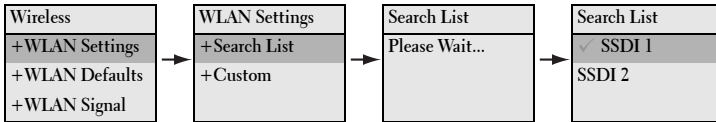

For Dell 2355dn MFP:

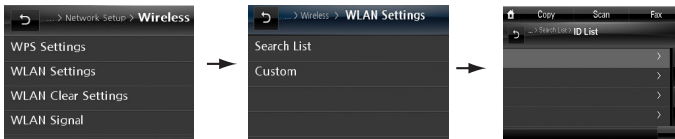

 **NOTE:**

- The Wireless Channel Number will not be seen unless Ad-hoc mode is selected.
- The Network key is case sensitive.
- When **Encryption** options are changed the Key lengths change accordingly.

	Hexadecimal	Alphanumeric
64-bit WEP	10 digits	5 characters
128-bit WEP	26 digits	13 characters

For more information on the security modes supported see your User's Guide available on your *Drivers and Utilities or Software and Documentation* CD or on <http://support.dell.com>.

- 4 Verify that the Dell Internal Wireless Adapter is correctly configured to your network by printing a **Configuration Page**.

For Dell 5330dn Mono Laser:

- a Press **Menu** (☰).
- b Press **Scroll** (∧ or ∨) to highlight **Reports** and press **Select** (✓).

- c Press **Scroll** (∧ or ∨) to highlight **Network Settings** and press **Select** (✓).
- d The printer **Configuration Page** is printed.

For Dell 2335dn MFP:

- a On the main menu of the operator panel, scroll to **Setup** using **Scroll** (< or >) and press **Select** (✓).
- b On the **Setup** menu, scroll to **Reports** using **Scroll** (∧ or ∨) and press **Select** (✓).
- c On the **Reports** menu, scroll to **Network Settings** using **Scroll** (∧ or ∨) and press **Select** (✓).
- d The printer **Configuration Page** is printed.

For Dell 2355dn MFP:

- a Press **Setup** → **Machine Setup** from the home screen.
- b Press the **Next** (▶) button.
- c Press the up/down arrows to select **Reports**.
- d Press the up/down arrows to select **Network Settings**.
- e The printer **Configuration Page** is printed.

- 5 Insert the *Drivers and Utilities or Software and Documentation* CD. The **setup.exe** file launches automatically.

In the event that it does not open, launch the **setup.exe** file from the *Drivers and Utilities or Software and Documentation* CD.

- 6 Select **Network Installation** and follow the on-screen instructions. *Grant Access* to the Dell installation software if any firewall warnings appear.
- 7 Once you have configured the printer, you may want to print a **Configuration Page** to confirm your settings.

For Dell 5330dn Mono Laser:

- a Press **Menu** (☰).
- b Press **Scroll** (∧ or ∨) to highlight **Reports** and press **Select** (✓).
- c Press **Scroll** (∧ or ∨) to highlight **Network Settings** and press **Select** (✓).

- d The printer **Configuration Page** is printed.

For Dell 2335dn MFP:

- a On the main menu of the operator panel, scroll to **Setup** using **Scroll** (< or >) and press **Select** (✓).
- b On the **Setup** menu, scroll to **Reports** using **Scroll** (∧ or ∨) and press **Select** (✓).
- c On the **Reports** menu, scroll to **Network Settings** using **Scroll** (∧ or ∨) and press **Select** (✓).
- d The printer **Configuration Page** is printed.

For Dell 2355dn MFP:

- a Press **Setup** → **Machine Setup** from the home screen.
- b Press the **Next** (▶) button.
- c Press the up/down arrows to select **Reports**.
- d Press the up/down arrows to select **Network Settings**.
- e The printer **Configuration Page** is printed.

Method 2: (Dell 2355dn MFP only)

The Dell Internal Wireless Adapter can be configured at the printer's operator panel. If your machine and an access point (or wireless router) support Wi-Fi Protected Setup™ (WPS), you can easily configure the wireless network settings.

- The PBC (Push Button Configuration) method allows you to connect your machine to a wireless network by pressing the WPS (PBC) button on a Wi-Fi Protected Setup™ (WPS)-enabled access point (or wireless router) respectively.
 - The PIN (Personal Identification Number) method helps you connect your machine to a wireless network by entering the supplied PIN information on a Wi-Fi Protected Setup™ (WPS)-enabled access point (or wireless router).
- 1 Press **Setup** → **Machine Setup** from the home screen.
 - 2 Press the **Next** (▶) button.
 - 3 Press the up/down arrows to select **Network Setup**.

- 4 Press the up/down arrows to select **Wireless**.
- 5 Press the up/down arrows to select **WPS Settings**.
- 6 Select WPS mode you want.

For Connect via PBC mode:

- a Press **Connect via PBC** on the touch screen.
- b Press  to start connection. (Information window appears showing 2 minutes connection processing time.)
- c Press the WPS (PBC) button on the access point (or wireless router) within the 2 minutes connection.
- d The machine is connecting to the access point (or wireless router).
- e After completing the wireless network connection process, AP's SSID information appears on the display.

For Connect via PIN mode:

- a Press **Connect via PIN** on the touch screen.
- b Press  to start connection. (Information window appears showing 2 minutes connection processing time.)
- c An eight-digit PIN appears on the touch screen. Enter this eight-digit PIN into the computer which is connected to the access point (or wireless router). This needs to be done during the 2 minutes connection.



NOTE: Need to enter the PIN into access point (or wireless router) wireless configuration page through the web browser.

- d The machine is connecting to the access point (or wireless router).
- e After completing the wireless network connection process, AP's SSID information appears on the display.

- 7 Insert the *Drivers and Utilities or Software and Documentation* CD. The **setup.exe** file launches automatically.

In the event that it does not open, launch the **setup.exe** file from the *Drivers and Utilities or Software and Documentation* CD.

- 8 Select **Network Installation** and follow the on-screen instructions.
Grant Access to the Dell installation software if any firewall warnings appear.

- 9 Once you have configured the printer, you may want to print a **Configuration Page** to confirm your settings.
 - a Press **Setup** → **Machine Setup** from the home screen.
 - b Press the **Next** (▶) button.
 - c Press the up/down arrows to select **Reports**.
 - d Press the up/down arrows to select **Network Settings**.



NOTE: After completing the connection, you can check the AP's SSID information.

- a Press **Setup** → **Machine Setup** from the home screen.
- b Press the **Next** (▶) button.
- c Press the up/down arrows to select **Network Setup**.
- d Press the up/down arrows to select **Wireless**.
- e Press the up/down arrows to select **WLAN Signal**.
- f Confirm the AP's SSID name and status.

Method 3:

Dell printers contain an **Embedded Web Server (EWS)** that can be accessed from a compatible web browser over the internet. The EWS provides management and configuration access for the Dell printer including its network and wireless settings. The printer IP address is required to access its **Embedded Web Server**.



NOTE: The Dell Internal Wireless Adapter is shipped in Ad-Hoc mode by default. To configure the Dell Internal Wireless Adapter in Ad-Hoc mode, you must access the printer's Embedded Web Server using a direct connection to your computer. This is only recommended for advanced users.

Identifying the printer's IP address

- 1 Turn on the printer.

There are two ways to access the printer from your computer.

Either;

- Connect the supplied Ethernet cable to connect the printer to a LAN network port/ router.

Or,

- Temporarily connect one end of the supplied Ethernet cable to the printer and the other to your wireless enabled computer. You may need to change your PC network IP settings to communicate with the printer. *See page 20 for instructions.*



NOTE: Upon powering on, Dell printers attempt to retrieve an IP address by checking on the availability of BOOTP or DHCP. If no DHCP or BOOTP exists on the network, the printer will automatically assign an IP address (192.0.0.192) or a local IP address (169.254.xxx.xxx).

2 Print a Configuration Page and identify the printer's IP address

For Dell 5330dn Mono Laser:

- a Press **Menu** (☰).
- b Press **Scroll** (∧ or ∨) to highlight **Reports** and press **Select** (✓).
- c Press **Scroll** (∧ or ∨) to highlight **Network Settings** and press **Select** (✓).
- d The printer **Configuration Page** is printed.

For Dell 2335dn MFP:

- a On the main menu of the operator panel, scroll to **Setup** using **Scroll** (< or >) and press **Select** (✓).
- b On the **Setup** menu, scroll to **Reports** using **Scroll** (∧ or ∨) and press **Select** (✓).
- c On the **Reports** menu, scroll to **Network Settings** using **Scroll** (∧ or ∨) and press **Select** (✓).
- d The printer **Configuration Page** is printed.

For Dell 2355dn MFP:

- a Press **Setup** → **Machine Setup** from the home screen.
- b Press the **Next** (▶) button.
- c Press the up/down arrows to select **Reports**.
- d Press the up/down arrows to select **Network Settings**.
- e The printer **Configuration Page** is printed.

Using the printer's Embedded Web Server to configure the Dell Internal Wireless Adapter

- 1 Launch your internet browser window and type in the IP address of the printer in the address bar. (As seen on the **Configuration Page**.)

You have now accessed the printer's **Embedded Web Server (EWS)**. You are ready to configure the wireless settings.

- 2 Select the **Wireless** option on the left pane.

This may differ from your machine depending on its model.

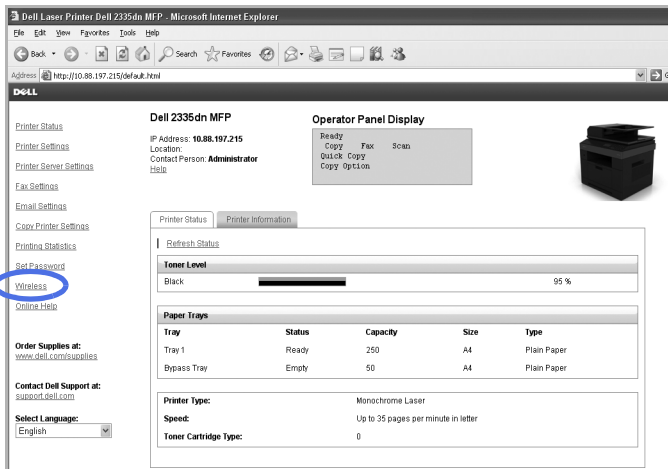

- 3 Select either **Wizard** (recommended) or **Custom** to set your network information.

- **Wizard Mode:** In this mode the setup is automatic. Printer will display a list of available network to choose. After a network is chosen then printer will prompt for the corresponding security Key.

Or

- **Custom Mode:** In this mode users can give their own SSID or edit SSID, choose the security manually and apply the settings.

- After you have set your network settings, click the **Apply** button at the bottom of the page to confirm and apply your wireless settings and remove Ethernet cable to start Wireless Network connection.

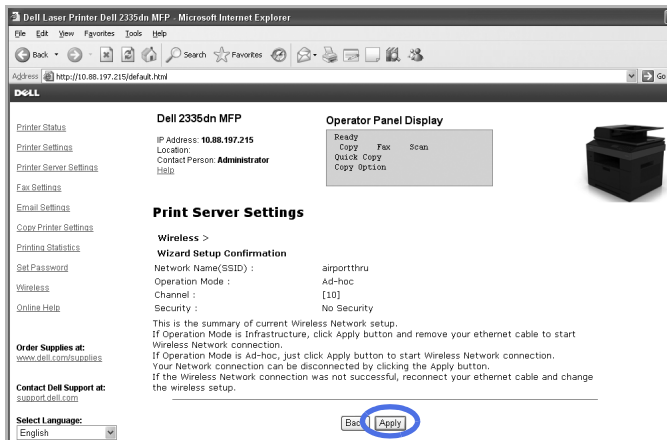

- Verify that the Dell Internal Wireless Adapter is correctly configured to your network by printing a **Configuration Page**.

For Dell 5330dn Mono Laser:

- Press **Menu** (☰).
- Press **Scroll** (▲ or ▼) to highlight **Reports** and press **Select** (✓).
- Press **Scroll** (▲ or ▼) to highlight **Network Settings** and press **Select** (✓).
- The printer **Configuration Page** is printed.

For Dell 2335dn MFP:

- On the main menu of the operator panel, scroll to **Setup** using **Scroll** (< or >) and press **Select** (✓).
- On the **Setup** menu, scroll to **Reports** using **Scroll** (▲ or ▼) and press **Select** (✓).
- On the **Reports** menu, scroll to **Network Settings** using **Scroll** (▲ or ▼) and press **Select** (✓).
- The printer **Configuration Page** is printed.

For Dell 2355dn MFP:

- a Press **Setup** → **Machine Setup** from the home screen.
- b Press the **Next** (▶) button.
- c Press the up/down arrows to select **Reports**.
- d Press the up/down arrows to select **Network Settings**.
- e The printer **Configuration Page** is printed.



NOTE: If you changed your computer's proxy or IP settings, restore them to their original settings.

- 6 Insert the *Drivers and Utilities or Software and Documentation* CD. The **setup.exe** file launches automatically.

In the event that it does not open, launch the **setup.exe** file from the *Drivers and Utilities or Software and Documentation* CD.

- 7 Select **Network Installation** and follow the on-screen instructions.
Grant access to the Dell installation software if any firewall warnings appear.

Appendix:

If you are using a direct computer to printer connection and are unsure as to how to change your computer's IP address, please follow the instructions below.

This troubleshooting guide is for Windows XP operating systems only; if you are using a different operating system, please refer to your operating system's help.



NOTE: You will need to disable any proxy server settings used in your computer (if applicable).

If you are using Windows XP Internet Explorer 6 this can be done by opening a web browser window, selecting

Tools → Internet Options → Connections → LAN Settings → Proxy Server.

Setting the IP address of your computer to match the IP address seen on the Network Settings page.

If you are using Windows XP, you may use the following method.

- 1** Select **Network Connections** in the computer's Control Panel.
- 2** Select the LAN wired connection you are using. Right-click and select **Properties**.
- 3** Find **Internet Protocol (TCP/IP)**. Select it and view its **Properties**.
- 4** Take note of the current settings on the **Properties** screen. You must restore these settings to your computer once the Dell Internal Wireless Adapter has been configured.
- 5** Select **Use the following IP address**.
- 6** For IP address, enter the first three numbers sets to match the IP address of the printer (as seen on the **Configuration Page** printed). You must vary the last set of numbers so that it is different from the IP address of the printer.
E.g. If the IP address assigned to the printer is 192.0.0.192, you must set your computer's IP address within the same range (e.g. 192.0.0.191 or 192.0.0.193)
- 7** Copy the Subnet mask and Default gateway as seen on the **Configuration Page**.
- 8** You should now be able to access the printer's **Embedded Web Server**.

- 9 Proceed to "Using the printer's Embedded Web Server to configure the Dell Internal Wireless Adapter" on page 17 to complete configuring Dell Internal Wireless Adapter.



NOTE: Remember to restore the proxy and IP settings on your computer once you have completed configuring the Dell Internal Wireless Adapter.

Appendix A. SetIP Address Utility

This program is for the network IP setting using the MAC address which is the hardware serial number of the network printer card or interface. Especially, it is for the network administrator to set several network IPs at the same time.

 **NOTE:** You can only use **Set IP Address Utility** when your printer is connected to a network.

- 1 Connect the straight network cable to your printer/MFP.
- 2 Print the Network Configuration page of the printer/MFP to see the current network configuration and MAC address. Refer to a user's guide of your printer/MFP to print the network configuration page.
- 3 From the **Start** menu, select **Programs** → **Dell** → **Dell Printers** → your printer driver name → **Set IP Address Utility**.

Or

From the **Start** menu, select **Programs** → **Dell Printers** → your printer driver name → **Set IP Address Utility**.

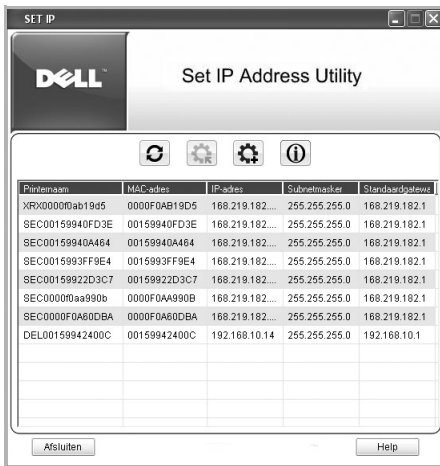

- 4 Click in the SetIP window to open the TCP/IP configuration window.
- 5 Enter the network card's MAC address, IP address, subnet mask, default gateway, and then click **Apply**.

 **NOTE:** when you enter the MAC address, enter it without colon(:).

- 6 Click **OK**.
- 7 Click **Exit** to close the SetIP program.

Appendix B. Management protocols

Before using your network printer/MFP, you may need to check or configure some parameters using management protocols.

DHCP/BOOTP

Dynamic Host Configuration Protocol (DHCP) is a communication protocol enabling network administrators to centrally manage and to automate the assignment of IP addresses in a network. In an IP network, each device needs a unique IP address. DHCP lets a network administrator supervise and distribute IP addresses from a central point and automatically sends a new IP address when a device is plugged into a different place in the network.

Bootstrap Protocol (BOOTP) is UDP/IP-based protocol which allows a booting host to configure itself dynamically and without user supervision. BOOTP provides means to notify a host of its assigned IP address, the IP address of a boot server host, and other configuration information, such as the local subnet mask, the local time offset, and the addresses of default routers. Addresses of various Internet servers can also be transferred to a host using BOOTP.

DHCP is active by factory default on your network print server. After boot up, the network print server will get an IP address automatically from the DHCP server, if one exists. To set an IP address manually, see User's Guide.

Configuring DHCP/BOOTP

To enable or disable DHCP/BOOTP, use one of printer/MFP's control panel or Embedded Web Service (EWS).

HTTP

Hypertext Transfer Protocol (HTTP) is an application layer protocol for distributed, collaborative, hypermedia information systems. It is a generic, stateless protocol which can be used for many tasks beyond its use for hypertext, such as with name servers and distributed object management systems. You are using HTTP when you connect your network printer via a web browser.

The network interface card has a built-in web server, EWS. You can configure and manage your network print server through **Embedded Web Service** using HTTP over TCP/IP.

SNMP

Simple Network Management Protocol (SNMP), which is part of the TCP/IP protocol suite, is an application layer protocol that facilitates the exchange of management information between network devices. It enables network administrators to remotely monitor and configure network devices, find and solve network problems, and plan for network growth.

Network devices are monitored and controlled using four basic SNMP commands:

- **Get:** is used by a Network Management server to monitor network devices. The server examines different variables that are maintained by the devices.
- **Set:** is used by a Network Management server to control managed devices. The server changes the values of variables stored within the devices.
- **trap:** is used by network devices to asynchronously report events to a Network Management server. When certain types of events occur, a device sends a trap to the specified server.
- **Get Next:** are used by a Network Management server to determine which variables a network device supports and to sequentially gather information in variable tables, such as a routing table.

Configuring SNMP

To access your network print server using SNMP, Community Name/Access Permission pair must be properly specified. There are two access permissions: read and write.

Assign the IP addresses of trap hosts and community names (IP addresses) of network devices in **Embedded Web Service**; go to **Printer Server Settings** → **Print Server Settings**.

Using SNMP

EWS accesses, configures, and manages network devices using SNMP. You can use other MIB (Management Information Base) browser software, which allows you to access management information gathered from network devices.

SLP

Service Location Protocol (SLP) is an Internet standard network protocol that provides a framework to allow networking applications to discover the existence, location, and configuration of networked services in enterprise networks, such as printers, Web servers, fax machines, video cameras, file systems, backup devices (tape drives), databases, directories, mail servers, and calendars.

In order to locate services on the network, users of network applications are required to supply the host name or network address of the device that supplies a desired service. However, SLP eliminates the need for a user to know the name of a network host supporting a service. Rather, the user only needs to supply the desired type of service and set of attributes or keywords, which describe the service.

Based on that description, SLP also resolves the network address of the service of the user. Administrators do not need to help clients find new services or to remove services when they are no longer available. SLP uses multicasting and can work over subnet boundaries.

Configuring SLP

You can configure SLP protocol settings through **Embedded Web Service**. Go to **Printer Server Settings** → **Print Server Settings** → **SLP**.

- **SLP Protocol:** You can enable or disable SLP.
- **Scope 1 ~ 3:** A scope is a set of services and a string used to group resources by location, network, or administrative category. Each scope should not be more than 32 characters.
- **Message Type:** You can select the outgoing SLP message type sent to network devices. The default value is **Multicast**.
- **SLP Multicast TTL:** The value is from 1 to 255.
- **Registration Lifetime, Hours:** You can define the time in seconds before the Server Agents registration expires.
- **SLP MTU:** The value is from 484 to 32768.
- **SLP Port In Use:** The port number is fixed to 427.
- **Multicast Address:** The Multicast Address value is fixed to 239.255.255.253, 224.0.1.127.

Using SLP

Once SLP is enabled, the network print server works as a Service Agent and the User Agent, for example, EWS, searches for the network print server by SLP Protocol.

Dynamic DNS (DDNS)

DNS (Domain Name System) is used for registration of domain names and provides Host names to an IP address resolution service. For printer devices, DNS may be utilized for printer domain name registration, so that print server clients may refer to the printer by its host name rather than by its IP address. Even though a printer's IP address is changed, all clients can operate this printer without reconfiguration. Addressing to a printer device by IP address is not convenient and may often go stale if an IP address to a device is assigned dynamically via a DHCP server. If the DHCP server can provide information about a printer's changing IP address to the DNS server automatically, user convenience is increased. The printer's name will be used as its DNS name.

Configuring DDNS

- 1 Let the DHCP server provide updated information to the DNS server.
- 2 Configure the same DDNS domain through **Embedded Web Service** as entered in the DNS server.

If you connect your network printer via a web browser, you can enable this option. go to **Printer Server Settings** → **Print Server Settings** → **TCP/IP** → **DNS Server Address**

- 3 Set the IP assignment method of your network print server to **DHCP** and reboot the printer.

The DNS server will update its database and users can use the printer's name instead of its IP address.

WINS

Before Dynamic DNS was defined, DNS could only be updated manually when DHCP servers automatically provided (or removed) IP addresses. As a result, DNS servers often contained obsolete listings. In response, Microsoft developed Windows Internet Name Service (WINS) to solve this problem for NetBIOS names.

Microsoft recommends moving to Dynamic DNS and away from WINS. However, many customers including Microsoft maintain WINS systems and need devices to interoperate with WINS. So devices must, at least for now, support WINS interoperability to allow for dynamic NetBIOS name to IP address registration and resolution.

WINS provides a distributed database for registering and querying dynamic NetBIOS names to IP address mapping in a routed network environment. This is the best choice for NetBIOS name resolution in such a routed network because it is designed to solve the problems that occur with name resolution in complex Internet networks.

Configuring WINS

Access **Embedded Web Service** and go to **Printer Server Settings → Print Server Settings → TCP/IP → Primary WINS Server Address/Secondary WINS Server Address**. You will configure two WINS server addresses, the Primary WINS Server or the Secondary WINS Server. The default value is 0.0.0.0.

In a DHCP server

A DHCP server can support the NBNS (NetBIOS Name Server) option. An administrator has to set the WINS server IP address in the NBNS option.

- 1 Set the IP assignment method of your network print server to DHCP.
- 2 Reboot the print server.

The WINS server will update the printer's NetBIOS name in its database. Users can use the printer name instead of its IP address.

In the network print server

- 1 Configure the WINS server address through **Embedded Web Service**.
- 2 Reboot the print server.

The WINS server will update the printer's NetBIOS name in its database. Users can use the printer name instead of its IP address.

Bonjour

Bonjour allows for a network system to be easily discovered and its capabilities to be revealed by any Bonjour-compliant client software, such as Print Center Utility built in to Mac OS X. For details, see page 43.

UPnP

UPnP is an architecture for pervasive peer-to-peer network connectivity of intelligent appliances, wireless devices, and PCs of all form factors. It is designed to bring easy-to-use, flexible, standards-based connectivity to ad-hoc or unmanaged networks whether in the home, in a small business, public spaces, or attached to the Internet.

UPnP is a distributed, open networking architecture that leverages TCP/IP and Web technologies to enable seamless proximity networking in addition to control and data transfer among networked devices in the home, office, and public spaces.

UPnP is more than just a simple extension of the plug and play peripheral model. It is designed to support zero-configuration, “invisible” networking, and automatic discovery for a wide breadth of device categories from a wide range of vendors. This means a device can dynamically join a network, obtain an IP address, convey its capabilities, and learn about the presence and capabilities of other devices. DHCP and DNS servers are optional and are used only if available on the network, while a device can leave a network smoothly and automatically without leaving any unwanted state issues behind.

UPnP supports 6 protocol stacks for addressing, discovery, description, control, eventing, and presentation, but the wireless network interface card supports only Simple Service Discovery Protocol (SSDP) which allows addressing, description, and discovery.

Configuring UPnP

- Control panel: Refer to the Network Menu setting in your printer user's guide.

- **Embedded Web Service (EWS):** Select **Printer Server Settings** → **Print Server Settings** → **UPnP(SSDP)**.
 - **Auto IP Enabled:** You can enable or disable Auto IP. When this option is selected, the network print server cannot find the control point and receive an IP address from the control point. The network print server will create an IP address of “169.254.XXX.XXX.”
 - **Multicast DNS Enabled:** SSDP can use Multicast DNS.
 - **SSDP Enabled:** You can enable or disable SSDP.
 - **SSDP TTL:** You can specify the maximum number of subnets that SSPD multicasts can travel across.

Using UPnP

If SSDP (Simple Service Discovery Protocol) is enabled, your network print server is checked by a control point. This control point is an application which supports finding UPnP devices. Information on searching and control functions or your network print server’s device information is displayed in an XML page (<http://xxx.xxx.xxx.xxx:5200/printer.xml>).

Appendix C. Printing protocols

Before setting the network printing ports, you must install the printer driver with the local port (LPT) on the system. Refer to your printer/MFP user's guide.

Standard TCP/IP port

You can print your documents to your network printer by creating a Standard TCP/IP port.

Configuring Standard TCP/IP in Windows 2000/XP/Server 2003/Server 2008/Vista/7/Server 2008 R2

You can enable or disable the Standard TCP/IP Printing port through EWS (Embedded Web Service).

You can also change the port number of the Standard TCP/IP port. The default port number is 9100.

Creating a Standard TCP/IP port

- 1 For Windows 2000, click the **Start** button → **Settings** → **Printer**.

For Windows XP/ Server 2003, click the **Start** button and point to **Printers and Faxes**.

For Windows Vista/Server 2008, click the **Start** button and click **Control Panel** → **Hardware and Sound** → **Printers**.

For Windows 7, click the **Start** button and click **Control Panel** → **Hardware and Sound** → **Devices and Printers**.

For Windows Server 2008 R2, click the **Start** button and click **Control Panel** → **Hardware** → **Devices and Printers**.

- 2 Click **Add a printer** or double-click **Add Printer**, and then **Next**.
- 3 Click **Local printer attached to this computer** or **Local printer** and then **Next**.

Make sure that **Automatically detect and install my Plug and Play printer** is not selected.

- 4 Click **Create a new port**, select **Standard TCP/IP port** from the Type of port list, and click **Next**.
- 5 Click **Next**.

- 6 Enter the IP address or DNS name of your network printer and click **Next**. For the port name, a default name will be entered by Windows. You can change it to a more user-friendly name.
- 7 Follow the instructions on the screen to complete installation.

Now, you can select your printer from the Print Setup dialogue box.

LPR port

LPD, Line Printer Daemon, is the protocol associated with line-printer spooling services. Users can use the printing service from LPD running on a network print server through the LPR port. Most operating systems, such as Microsoft Windows 2000/XP/Server 2003/Server 2008/Vista/7/Server 2008 R2, Linux, and UNIX, support LPR port printing.

Configuring an LPR port

You can enable or disable the LPR Printing port through **Embedded Web Service**.

In Windows 2000/XP/Server 2003/Server 2008/Vista/7/Server 2008 R2

To add an LPR port to Windows 2000/XP/Server 2003/Server 2008/Vista/7/Server 2008 R2, users must install a Standard TCP/IP port by default, and then change the printing protocol in the printer properties. For installing the Standard TCP/IP port, see page 30.

- 1 For Windows 2000, click the **Start** button → **Settings** → **Printer**.
For Windows XP/Server 2003, click the **Start** button and point to **Printers and Faxes**.
For Windows Vista/Server 2008, click the **Start** button and click **Control Panel** → **Hardware and Sound** → **Printers**.
For Windows 7, click the **Start** button and click **Control Panel** → **Hardware and Sound** → **Devices and Printers**.
For Windows Server 2008 R2, click the **Start** button and click **Control Panel** → **Hardware** → **Devices and Printers**.
- 2 Right-click the printer you want and select **Properties**.
- 3 Click **Ports**.

- 4 Make sure that the appropriate Standard TCP/IP port is selected and click **Configure Port**.
- 5 Select **LPR** from the Protocol section.
- 6 Enter the print queue name and click **OK**.
- 7 Click **OK** to close the properties window.

In Unix

Depending on your particular Unix system, LPD configuration may vary. See your system documentation for the correct syntax for the system.

IPP port

Internet Printing Protocol (IPP) allows printing across the Internet, meaning that you can send a print job to your printer from a remote place if you are an Internet user, no matter what operating system you use or where you are.

Configuring IPP in the print server

The network administrator must specify information required for IPP, such as the URI (Uniform Resource Identifier).

- 1 Run your web browser and access **Embedded Web Service**.
- 2 Click **Printer Server Settings** → **Print Server Settings** → **IPP**.
- 3 Configure the IPP parameters:
 - **IPP Protocol:** Set this value to Enabled to use IPP protocol or Disabled not to use.
 - **Network Path:** Enter the URL of the printer using the following format: ipp://the IP address of the printer or http://the IP address of the printer:631 (Ex:ipp://168.10.17.82 or http://168.10.17.82:631) 631 is the IPP port number.
 - **Authentication Scheme:** Select a scheme among None, Basic and Digest. The Digest scheme is based on a simple challenge-response paradigm which is using a nonce value that is generated by server uniquely and randomly. A valid response contains a checksum (by default, the MD5 checksum) of the username, the password, the given

nonce value, the HTTP method, and the requested URI. In this way, the password is never sent in the clear to avoid the most serious flaws of Basic authentication.

- **User Name, Password:** The user name and password can include A to Z, a to z, 0 to 9, and other symbols !#\$%&()+-./{}~_@.
- **Verify Password:** The valid character is same as Password.

4 Click **Submit**.

Setting IPP security

EWS allows administrators to choose an authentication method and to create or modify user accounts.

1 Run your web browser and access **Embedded Web Service**.

2 Click **Printer Server Settings** → **Print Server Settings** → **IPP**.

- **Authentication:** You can set a user name and password encryption method (refer to http digest authentication in RFC).
- **User DB:** You can set a user name and password for IPP printing. You can set up the user database for up to 10 items.

3 Click **Submit**.



NOTE: A user name should be unique for all slots and should not include symbols. The length of the user name and the password should each be less than 7 characters.

Appendix D. Additional functions

The following are additional functions you can use through EWS (Embedded Web Service).

Printer properties settings

You can check and modify printer and document properties for an installed printer. For properties that are not supported by the printer driver, an error message indicating that the property is not supported is displayed. These settings are used only for printing from this system to the printer. However, these settings do not affect the printer properties of the network printer.

Firmware upgrade (HTTP)

You can upgrade your printer's firmware using the HTTP protocol. First, you need to download firmware from the Dell website (<http://support.dell.com>.)

 **NOTE:** Before upgrading the firmware, make sure that TCP/IP parameters are entered in the print server.

- 1 Run your web browser and access **Embedded Web Service**.
- 2 Click **Printer Settings** → **Maintenance** → **Update Print Server Firmware**.
- 3 Click **Browse**, and then select the downloaded new firmware.
- 4 Click **Update Printer Firmware**.

 **NOTE:** It takes a few minutes to upgrading the firmware. After completely upgrade, the printer will be reset.

Default setting (HTTP/SNMP)

You can reset all of your network parameter settings to their default status.

 **NOTE:** All default parameters will be applied after the print server restarts.

IP filtering

This security feature (IP Filtering) provides the ability to prevent unauthorized network access to the network print server based on IP addresses set by a network administrator using EWS.

- 1 Run your web browser and access **Embedded Web Service**.
- 2 Select **Printer Server Settings** → **Other Features** → **IP Filtering Enable**.

3 Configure an IP filter.

- **IP Filtering Enable:** You can enable or disable IP filtering.
- **IP Address 1 ~ IP Address 10:** You can enter filtered IP addresses. Users having the IP addresses set here are able to access the network print server.
- **IPv6 Filtering Enable:** You can enable or disable IPv6 filtering.

4 Click **Submit**.

Only system administrators or authorized users can set, via EWS, IP addresses that can access the device. Up to 10 addresses or ranges of address choices can be made and set. Authorized users are able to change the action (Apply/ Undo) and to print to the network print server..

 **NOTE:** Ranges of addresses shouldn't contain "null" or "0.0.0.0" values.

Restart

- 1 Run your web browser and access **Embedded Web Service**.
- 2 Click **Printer Server Settings** → **Other Features** → **Restart Machine**.

You can reboot the network print server, if your network settings are not applied correctly or the network card is disconnected from your network.

Ethernet speed

You can set the communication speed for Ethernet connections.

- 1 Run your web browser and access **Embedded Web Service**.
- 2 Click **Printer Settings** → **Print Settings** → **Network Menu**.
 - **Speed:** Automatic, 10 Mbps(Half Duplex), 10 Mbps(Full Duplex), 100 Mbps(Half Duplex),100 Mbps(Full Duplex). select a Ethernet speed from the drop-down list.
 - 1000 Mbps(Full Duplex) for Dell 5330dn Mono Laser Printer only.
- 3 Click **Submit**.

Appendix E. Netware environment

This wireless network interface card is compatible with Novell NetWare networks in versions 3.x, 4.x, 5.x, and 6.x. You can print to the network printer from any NetWare client that is attached to the network. This section describes how to continue printing with your network printer card in a NetWare environment.

 **NOTE:** This section is applicable for Dell 5330dn Mono Laser Printer.

NetWare printing

The NetWare architecture for printing is comprised of the following:

Printers

These are the physical printers, which may be attached either to NetWare file servers, NetWare machines dedicated as print servers, NetWare workstations, or directly to the network. The network printer falls into the last category.

Print queues

These queues are found on NetWare file servers where print jobs are stored before printing.

Print servers

These are programs that transfer print jobs from the print queues to the printers. Print servers may operate from various points in the NetWare network:

- They may be present on the NetWare file server (RPRINTER mode). This puts an additional load on the file server.
- They may be present on the printers themselves (PSERVER mode). This relieves the file server of a printing load and does not require any dedication of NetWare machines as print servers. Printing performance will be improved as the printer will have optimized software and hardware to accommodate network printing. Also, the print server and physical printer are in close proximity and print data need not travel over the network from print server to printer.

Additionally, printers connected to NetWare workstations may be shared with the rest of the network. This is done by running RPRINTER on the workstation and configuring the printers as Remote Printers. Print servers on the network may then interact with the RPRINTER program on the

workstation for printing. Configuration for NetWare printing involves creation of printers, print queues, and print servers, and the associations between them on the NetWare file server.

The file server configuration for printers, print queues, and print servers may be achieved using NetWare supplied utilities, such as PCONSOLE and NWADMIN.

Configuring NetWare

NetWare Setup allows you to enter the names of the NetWare objects that are concerned with network print jobs. The NetWare print queues must be assigned to the NetWare print servers you have set up for printing to the network printer card. When you enable NetWare Setup, you can set up NDS (Novell Directory Services), Bindery Services, or both. NDS is used with NetWare 4.x/5.x/6.x; Bindery Services are used with NetWare 3.x or with NetWare 4.x/5.x/6.x in bindery emulation mode.

You can set up IPX/SPX in **Embedded Web Service**. Select **Printer Server Settings** → **Print Server Settings** → **Netware**.

- **Netware Protocol:** Select this option if you have a NetWare network connected with the network print server.
- **Frames Type:** You can select among Ethernet_802.2, Ethernet_802.3, Ethernet_II, SNAP. You must select at least one frame type.
- **Queue Poll Interval:** Enter the Queue Poll interval between 1~300 that sets the time for checking jobs in Netware printer queue.
- **Printer Server Name:** Enter the name of the printer object for Netware server.
- **NDS Tree:** Enter the name of the NDS tree that contains the printer, print server, and print queue objects you have previously defined on the NetWare server for the network print server.
- **NDS Context:** Enter the name of the NDS Context object as "name.context".
- **Primary File Server:** Enter the name of the NetWare server on which you have configured a print server and a print queue to handle network printing.

- **IPX/SPX mode configuration:** Configure IPX/SPX mode for your NetWare system.
 - **Bindery configuration:** You can set up the bindery server.
 - **Bindery Setup:** Use this option if you have already configured one or more bindery servers (file servers running NetWare 3.x, or 4.x, 5.x, or 6.x in bindery emulation) with a print server and a print queue for network printing. Before entering bindery settings, The network print server connected to the network and the NetWare file server must be running. If access to the file server or print server is restricted, you need to log in to a NetWare Client system.
 - **Bindery Print Server:** Enter the name of the print server that you have configured in the NetWare utility PCONSOLE. This is the print server that will route print jobs to the network print server from NetWare Client on IPX networks.
 - **File Server:** Enter the name of the NetWare server on which you have configured a print server and a print queue to handle network printing.
 - **NDS configuration:** You can set up the NDS server.
 - **Enable/Disable NDS:** If NetWare servers you will use to print to the network print server are running NetWare 4.x/5.x/6.x in native mode.
 - **NDS Tree:** Enter the name of the NDS tree that contains the printer, print server, and print queue objects you have previously defined on the NetWare server for the network print server. Your new NDS tree selection automatically overwrites any previous tree selection. If you change the NDS tree selection and there are also current Bindery settings, you are alerted that they will be deleted. If you continue with NDS Setup, you can replace Bindery settings afterwards.
 - **NDS Print Server:** Enter the name of the print server object as “name.context.”



NOTE: Use NDS Setup if your network uses NetWare 4.x/5.x/6.x in native mode. Use Bindery Setup if your network uses NetWare 3.X or uses NetWare 4.x/5.x/6.x in bindery emulation mode.

Printing in NetWare

To print to your network printer on a NetWare workstation, you need to add a print queue.

 **NOTE:** To use bindery emulation, you must log on to a Bindery server as an administrator. In the NDS mode, log on to target text of the NDS tree where you have administrator privileges.

Adding a queue

- 1 Open the NWADMIN dialogue box by double clicking on the NetWare Client.
- 2 Right-click **CONTEXT**, then choose the **create** menu.
- 3 You will need to create all of the following items:
 - Printer Server: represents a network print server.
 - Printer: represents a network printing device.
 - Printer Queue: represents a network print queue.

 **NOTE:** The New Object dialogue box lets you choose the class of object to create.

- 4 Double-click each tree print object and select **Assignments** menu.
- 5 Click **Add**.

The print server object which was created in Step 3 has a link assigned to the printer object and the printer object a link to the print queue object.

Adding a printer

- 1 Select **Add Printer** from the **Printer and fax** menu in the control panel.
- 2 Select **Network Printer** and click **Next**.
- 3 Select **Novell Directory Service**, and then click the context tree and an existing printer object name.
- 4 Click **Next**.
- 5 If the server does not provide the printer driver or there is no one available on the network, a dialogue box appears to allow users to select a printer driver. Select the driver and click **Next**.
- 6 Install the printer driver by following the onscreen instructions.

Appendix F. EtherTalk environment

EtherTalk is AppleTalk used in an Ethernet network. This protocol is widely used in Macintosh network environments. Microsoft Windows system also supports this protocol. Like TCP/IP, EtherTalk also provides packet transmission and routing functionality.

The network printer card works on EtherTalk networks, if the host printer supports PostScript. The description in this chapter applies to network printing from a Macintosh computer.

EtherTalk printing

Printing in an EtherTalk network is possible with several different hardware and software configurations. When you issue a command to print a document, the application begins a series of EtherTalk calls attempting to establish a connection to the printer. The calls first initiate the NBP (Name Binding Protocol) name-lookup process to find the currently selected printer and its EtherTalk address. Then the Printer Access Protocol (PAP) is used to open a connection with the printer.

Once the connection has been established, the workstation and printer interact over a PAP connection. PAP uses lower-level protocols, such as ATP and DDP, to provide a data-stream service for sending print data to the printer.

Configuring EtherTalk

You can configure EtherTalk using the following methods:

Control Panel

Refer to the information on this guide. See page 10

EWS (Embedded Web Service)

- 1 Run your web browser and access **Embedded Web Service**.
- 2 Select **Printer Server Settings** → **Print Server Settings** → **EtherTalk**.
 - **EtherTalk Protocol**: allows you to enable or disable the EtherTalk protocol.
 - **EatherTalk Printer Name**: allows you to set the printer name for EtherTalk protocol. The default name is DELL+MAC address. This name is automatically displayed on Chooser.

- **Printer Type:** shows the printer type.
 - **Zone:** shows the available printer zone list. You must select one.
 - **Page Description Language:** shows the EtherTalk protocol.
- 3 Click **Submit**.

Configuring the printer

NOTE: The following instructions are for Mac OS 10.3, but similar for other versions.

The following steps must be taken to configure the network printer for use on a Macintosh system. If the network printer you want to use is not listed in the printer pop-up menu when you try to print a document, you should add it to your list of available printers.

- 1 Open the **Applications** folder → **Utilities**, and **Print Setup Utility**.
For MAC OS 10.5~10.6, open **System Preferences** from the **Applications** folder, and click **Print & Fax**.
- 2 If the printer already appears in the printer list, select the **In Menu** check box to add it to your list of available printers. You will see the printer in the **Printer** pop-up menu the next time you print.
- 3 Click **Add** on the **Printer List**.
For MAC OS 10.5~10.6, press the “+” icon then a display window will pop up.
- 4 Choose an **AppleTalk** from the pop-up menu list on the top.
- 5 Choose an **AppleTalk** zone from the pop-up menu that appears directly below it.
Any **AppleTalk** printers in the zone you have chosen appear in the **Printer List**.
- 6 Select the printer in the **Printer List**.
- 7 For MAC OS 10.3, if **Auto Select** does not work properly, select **Dell** in **Printer Model** and your printer name in **Model Name**.
For MAC OS 10.4, if **Auto Select** does not work properly, select **Dell** in **Print Using** and your printer name in **Model**.
For MAC OS 10.5, if **Auto Select** does not work properly, select **Select a driver to use...** and your printer name in **Print Using**.

For MAC OS 10.6, if Auto Select does not work properly, select **Select Printer Software...** and your printer name in **Print Using**.

8 Click **Add**.

The printer appears in the **Printer List** as the default printer (in boldface). It also appears in the Printer pop-up menu when you print a document.

TCP/IP printing

Apple added TCP/IP printing to all versions including and after OS 10.3.



NOTE: Ensure that the Macintosh has version 10.3 or later. Earlier versions do not support TCP/IP printing as standard.

An IP printer is a network printer that uses TCP/IP protocols (such as LPD/LPR, IPP, or Socket or Jet Direct) to make itself accessible to your computer. If the IP printer you want to use is not listed when you want to print, you can add it to your list of available printers. To add an IP printer, you need to know its IP address or DNS name.

1 Open the **Applications** folder → **Utilities**, and **Print Setup Utility**.

For MAC OS 10.5~10.6, open **System Preferences** from the **Applications** folder, and click **Print & Fax**.

2 If the printer already appears in the printer list, select the **In Menu** check box to add it to your list of available printers. You will see the printer in the Printer pop-up menu the next time you print.

3 Click **Add** on the **Printer List**.

For MAC OS 10.5~10.6, press the “+” icon then a display window will pop up.

4 For MAC OS 10.3, select the **IP Printing** tab.

For MAC OS 10.4, click **IP Printer**.

For MAC OS 10.5~10.6, click **IP**.

5 Enter the printer’s IP address in the **Printer Address** field.

For MAC OS 10.5~10.6, enter the printer’s IP address in the **Address** field.

6 Enter the queue name in the **Queue Name** field. *If you cannot determine the queue name for your printer server, try using the default queue first.*

For MAC OS 10.5~10.6, enter the queue name in the **Queue** field.

- 7 For MAC OS 10.3, if Auto Select does not work properly, select **Dell** in **Printer Model** and your printer name in **Model Name**.

For MAC OS 10.4, if Auto Select does not work properly, select **Dell** in **Print Using** and your printer name in **Model**.

For MAC OS 10.5, if Auto Select does not work properly, select **Select a driver to use...** and your printer name in **Print Using**.

For MAC OS 10.6, if Auto Select does not work properly, select **Select Printer Software...** and your printer name in **Print Using**.

- 8 Click **Add**.

The printer appears on the **Printer List** as the default printer (in boldface). It also appears in the Printer pop-up menu when you print a document.

Bonjour printer

Usually used in Macintosh networks to search for network devices, Bonjour consists of IPv4 Link-Local Addressing, Multicast DNS, and DNS Service Discovery. Known as zero configuration networking, Bonjour uses industry standard IP protocols to allow devices to automatically find each other without the need to enter IP addresses or configure DNS servers.

In order to provide a true zero configuration experience, meaning that you do not need to configure network parameters, the printer **MUST** have Bonjour enabled by default. It is **NOT** possible to disable any part of Bonjour.

After boot up, check the Bonjour printer name of this printer network card in Mac OS X.

- 1 Open the **Applications** folder → **Utilities**, and **Print Setup Utility**.

For MAC OS 10.5~10.6, open **System Preferences** from the **Applications** folder, and click **Print & Fax**.

- 2 If the printer already appears in the printer list, select the **In Menu** check box to add it to your list of available printers. You will see the printer in the Printer pop-up menu the next time you print.
- 3 Click **Add** on the **Printer List**.

For MAC OS 10.5~10.6, press the “+” icon then a display window will pop up.

- 4 For MAC OS 10.3, select the **Rendezvous** tab.

For MAC OS 10.4, click **Default Browser** and find the **Bonjour**.

For MAC OS 10.5~10.6, click **Default** and find the **Bonjour**.

- 5 Any Bonjour-enabled printers on your local network or sub network appear on the **Printer List**.

- 6 Select your printer from the **Printer List**.

- 7 For MAC OS 10.3, if Auto Select does not work properly, select **Dell** in **Printer Model** and **your printer name** in **Model Name**.

For MAC OS 10.4, if Auto Select does not work properly, select **Dell** in **Print Using** and **your printer name** in **Model**.

For MAC OS 10.5, if Auto Select does not work properly, select **Select a driver to use...** and **your printer name** in **Print Using**.

For MAC OS 10.6, if Auto Select does not work properly, select **Select Printer Software...** and **your printer name** in **Print Using**.

- 8 Click **Add**.

The printer appears on the **Printer List** as the default printer (in boldface). It also appears in the Printer pop-up menu when you print a document.

Appendix G. Wireless network environment

Overview

The Wireless Network Printer Card supports the IEEE 802.11b/g standard for wireless LAN (WLAN) communications. Properly configuring your network's wireless settings on the print server will allow you to send print jobs to the print server over the WLAN. When a computer sends a file to the print server, a radio signal is transmitted. When the print server receives the incoming signal, either directly from the computer (Ad Hoc/Computer-to-Computer mode) or from an access point (Infrastructure/AirPort Network mode), it prints the file.

Basic concept and terms

This section provides you with information on the basic concepts and terms used for wireless networking.

Operation mode

The Wireless Network Printer supports two standard wireless operation modes, Ad hoc and Infrastructure.

- **Ad hoc (peer-to-peer) mode:** Ad hoc mode is also referred to as Peer-to-peer mode. In Ad hoc mode, wireless devices or workstations communicate directly with each other, without using an access point (AP). They can share files and printers, but may not be able to access the Internet. A print server receives print jobs from wireless computers directly. On Apple networks, Ad hoc mode is called "computer-to-computer" mode.

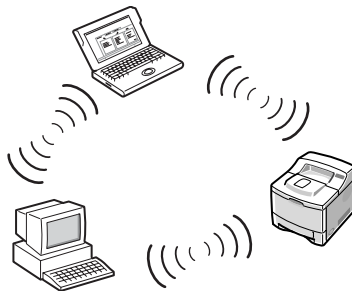

- **Infrastructure mode:** In Infrastructure mode, wireless devices or workstations communicate with each other through an access point (AP). The access point acts like a hub, providing connectivity for wireless computers. In Infrastructure mode, wireless devices can communicate with each other or can communicate with a wired network. On Apple networks, Infrastructure mode is called Airport Network mode. In this mode, the dell print server receives print jobs from wireless and wired network computers through an access point.

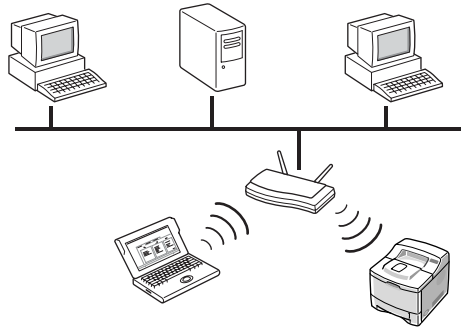

 **NOTE:** If you connect a network cable to the Network Printer, the print server will not use the wireless interface. All packets will be transferred via the wired LAN.

Access point

An access point is a device that acts as a wireless communication hub so that users of a wireless device can connect to a wired network. An access point must be able to receive and forward network traffic between wireless and cabled network devices. Multiple access points can act as repeaters to extend the range of a wireless network. To use Infrastructure mode, you need to use an access point.

Service Set Identifier (SSID)

The Service Set Identifier is the ID used to form a wireless network. You can set up to 32 characters in the SSID field. An identifier attached to packets sent over the wireless LAN functions as a password for joining a particular wireless network (BSS). All wireless devices and access points within the same BSS must use the same SSID. The SSID is also referred to as the network name because it is an identifying label for a wireless network.

Channels

There are several channels specified in the 802.11b/g standard for wireless communications. The number of available channels authorized for use may be restricted based on your location (generally regulatory domain). See Appendix for available channels at your location. When shipped from the factory, the Wireless Network Printer Card is configured for Ad-hoc mode using the automatic channel selection. In most cases, manual configuration of the channel is not required. If the print server discovers a wireless network that has the same SSID and operation mode when turned on, it will automatically adjust the channel to match that network.

IEEE 802.11 authentication

IEEE 802.11 authentication is a process of identifying an individual who is attempting to access a wireless LAN or an access point. The IEEE 802.11 standard defines two types of authentication services:

- **Open System:** Authentication is not used, and encryption may or may not be used, depending on the need for data security.
- **Shared Key:** Authentication is used. A device that has a proper WEP key can access the network. The Network Printer supports both authentication methods.

WEP encryption

WEP (Wired Equivalent Privacy) is a security protocol preventing unauthorized access to your wireless network. Wireless LANs, which communicate over radio waves, do not have a physical structure that can be protected from unauthorized access and therefore are vulnerable to tampering. WEP is designed to provide a wireless LAN with a security level equal to that found on a wired network. WEP encrypts the data portion of each packet exchanged on a wireless network using a 64-bit or 128-bit WEP encryption key.

Sometimes, 64-bit WEP is called 40-bit and 128-bit is called 104-bit. 40-bit and 64-bit encryption are really the same thing, as are 104-bit and 128-bit encryption, because an additional 24 initialization vector (IV) bits are automatically added to make a total of 64 bits and 128 bits. To encrypt data, the Wireless Network Printer uses four encryption keys. You must select a key and enter the key value. The key value must be the same as the other wireless devices or that of the access point of your wireless network. In 64-bit mode,

each key value is 10 hexadecimal digits (0-9 and A-F) or 5 alphanumeric characters. In 128-bit mode, each key value is 26 hexadecimal digits or 13 alphanumeric characters. Contact your network administrator for this configuration.

IEEE 802.1x (WPA-Enterprise Model Only)

IEEE 802.1x uses EAP (Extensible Authentication Protocol) and an authentication server, such as RADIUS (Remote Authentication Dial In User Server, RFC2138) for client and network server authentication. In this authentication process, the authentication server verifies the identity of the party attempting to connect to the network. The Wireless Network Printer supports popular authentication methods based on EAP, including:

- **EAP-MD5 (EAP using Message Digest Algorithm 5):** EAPMD5 uses a password protected by the MD5 encryption algorithm, which is the same challenge handshake protocol as PPP-based CHAP. This authentication method provides one-way authentication based on a user name and password. This implementation is useful only in a small private network because it does not support automatic key distribution.
- **EAP-MSCHAPv2:** EAP-MSCHAPv2 uses the MS-CHAPv2 authentication protocol to create a strong encryption key initially for MMPE (Microsoft Point-to-Point Encryption) and to use a different encryption key during communication.
- **EAP-TLS (EAP using Transport Layer Security):** EAP-TLS uses X.509-compliant digital certificates for both client and server authentication.
- **EAP-TTLS:** EAP-TTLS is known as a Tunneled TLS (Transport Layer Security) protocol. It is designed to provide authentication that is every bit as strong as EAP-TLS, but it does not require that each user be issued a certificate. Instead, only the RADIUS authentication servers are issued certificates. User authentication is performed by a password. The password credentials are transported in a securely encrypted tunnel that is established using the server certificate. As a result, the credentials are not vulnerable to dictionary attacks. Using TTLS forwarding, any inner authentication requests that are found inside the TTLS tunnel, such as EAP, PAP, CHAP, or MS-CHAP-V2, can be processed by downstream RADIUS servers. In this manner, you can perform authentication against any RADIUS infrastructure that is already deployed in your organization.

- **PEAP (Protected Extensible Authentication Protocol):** PEAP uses digital certificates for network server authentication and a password for client authentication.

WPA (Wi-Fi Protected Access)

WPA, announced by Wi-Fi Alliance, authorizes and identifies users based on a secret key that changes automatically at regular intervals. WPA uses 802.1x or WPA-PSK (WPA mode Pre-Shared Key) for authentication. WPA-PSK verifies users via a pre-shared key on both a client station and an access point. In WPA-PSK authentication, a client may only gain access to the network if the client's password matches the access point's password. WPA also uses TKIP (Temporal Key Integrity Protocol) and AES (Advanced Encryption Standard) for data encryption.

Certificates

Certificates are used to validate the identity of clients and network servers and allow encrypted data communications for EAP/802.1x authentication.

Certificates may be issued and signed by a trusted third party, called Certificate Authority (CA). In EAP/802.1x authentications, such as EAP-TLS, EAP-TTLS, and PEAP, the dell network print server may require one or both of the following certificates:

- **Root Certificate:** A certificate from a trusted Certificate Authority (CA) is used to validate the identity of a network authentication server while EAP authentication methods, such as EAP-TLS, EAP-TTLS, and PEAP, are performed. The network authentication server's identity will be validated when the root certificate information installed on the network print server is identical to the information on a certificate received from the network authentication server, such as RADIUS. To be installed on the Network Printer Card, a root certificate must be in the form of Base64 Encoded X.509 with a .cer extension and be less than 3,072 bytes.
- **Client Certificate:** A client certificate is used to validate the identity of the Network Printer from a network authentication server, such as RADIUS, while the EAP-TLS authentication method is performed. To be installed on the Network Printer, a client certificate must be in the form of PKCS #12 / Personal Information Exchange with a .pfx extension and be less than 3,072 bytes.

Network Status

This section displays information on the current wireless connection. This window appears when you select **Wireless** in EWS. The option items may differ due to the printer models.

- **Link Status:** indicates whether or not the WLAN interface is connected to other wireless devices.
- **SSID**
- **Operation Mode**
- **Associated Frequency:** indicates the associated frequency mode, for example, 802.11b/g.
- **BSSID:** displays the associated BSSID, for example, 00:02:78:E3:43:89.
- **Link Quality:** represents quality of the wireless link between the print server and an access point or other devices by percentage, for example, Excellent, Very Good.
- **Current Channel:** represents the associated channel, for example, [10] 2457 MHz.

Network setup

These are the basic parameters required to make wireless connections found on the **Wireless** menu of EWS. Click **Submit** after changing parameters.

- **SSID:** SSID (Service Set Identifier) is a name that identifies a wireless network. Access points and wireless devices attempting to connect to a specific wireless network must use the same SSID. The SSID is case-sensitive.
- **Operation Mode:** Operation Mode refers to the type of wireless connections. Choose one of the following options:
 - **Ad hoc:** allows wireless devices to communicate directly with each other in a peer-to-peer environment.
 -  **NOTE:** In Ad-Hoc mode, you may need to restart the print server depending on your wireless network device.
 - **Infrastructure:** allows wireless devices to communicate with each other through an access point.

- **Frequency Mode:** Choose a frequency mode. The dell print server supports 802.11b and 802.11g frequency modes.
 - **802.11b/g (2.4GHz) mode:** Data is sent using IEEE802.11g standard communications in the 2.4 GHz band. This mode is compatible with IEEE802.11b standard.
 - **802.11b/g (5GHz, 2.4GHz) mode:** Data is sent using the frequency range defined in IEEE802.11g standards.
- **Ad-hoc Channel:** Change the channel selection setting. If you select **Auto Setting**, the dell print server will automatically adjust channels. To manually set a channel, select **Channel Selection**. In most cases, manually setting up channels is not required.



NOTE: Your wireless basic setting changes will be applied after the print server restarts. In order to restart the print server, from EWS, select **Printer Server Settings** → **Other Features** → **Restart Machine** and click **Restart**, or turn the print server off and then back on.

Security setup

This section describes how to configure wireless security for your wireless network.

- **Authentication**
 - **Open System:** This is used if your wireless network does not require authentication for network access. However, your network may still use encryption keys for data security.
 - **Shared Key:** Use Shared Key authentication if your network requires that each device be configured with the same secret WEP key for network access.
 - **WPA-Personal, WPA2-Personal:** If you are using this option, the print server WPA shared key must be the same as that of an access point. The WPA shared key is used to authenticate and to create a master session key.
 - **WPA-Enterprise, WPA2-Enterprise:** You must select an authentication method which is supported by a RADIUS server. The authentication method is determined by negotiation between clients and the server. Therefore, it is not necessary for the selected authentication to be

higher priority on a RADIUS server. Available authentications are NONE, EAP-MD5, EAP MSCHAPv2 in 802.1x Authentication on Static WEB security.

- **Encryption:** This option will be changed due to the option you have selected in the Authentication field.

Network Key Setup

Enter the network key due to the Encryption option you have selected.

802.1x Security Setup

- **802.1x Authentication:** You must select an authentication method which is supported by a RADIUS server. The authentication method is determined by negotiation between clients and the server. Therefore, it is not necessary for the selected authentication to be higher priority on a RADIUS server. Available authentications are NONE, EAP-MD5, EAP MSCHAPv2 in 802.1x Authentication on Static WEB security. Refer to "IEEE 802.1x (WPA-Enterprise Model Only)" on page 48
- **Inner Authentication Protocol:** EAP-TTLS and PEAP allow for standard RADIUS protocols within their inner tunnel. User authentication is performed by a password. The password credentials are transported in a securely encrypted tunnel that is established using the server certificate. EAP-TTLS supports EAP-MD5, CHAP, MS-CHAP, and MS-CHAPv2. PEAP supports EAP-MD5 and MSCHAPv2 as inner authentications.
- **Identity Name:** EAP-TTLS has a unique feature, TTLS Identity, that other EAP authentication protocols do not offer. It passes your user name through an encrypted tunnel (generally called tunneled TLS) as your credentials. It uses TTLS Identity as your credentials before the encrypted tunnel is created.
- **User Name:** 802.1x EAP authentication methods, such as EAP-MD5, EAP-MSCHAPv2, EAP-TTLS, and PEAP, require an EAP user name as an account name. A user name is necessary, if 802.1x authentication is enabled. This is not saved as the default value.

- **User Password:** 802.1x EAP authentication methods, such as EAP-MD5, EAP-MSCAHPv2, EAP-TTLS, and PEAP, require an EAP user password as an account password. A user password is necessary, if 802.1x authentication is enabled. This is not saved as the default value.
- **Root certificate:** You can install a root certificate. To be installed on the Wireless Network Printer Card, a root certificate must be in the form of Base64 Encoded X.509 with a .cer extension and be less than 3,072 bytes. EAP-TLS, EAP-TTLS, and PEAP authentications need root certificates.
 - a Click **Configure**.
 - b If the root certificate has been configured, detailed information on the root certificate displays.
 - c Select the root certificate file.
 - d Upload the file and click **back** to return to the front page.
 - **Enable Server certificate Validation:** This option determines whether or not the client authenticates the server. If Server Certificate Validation is disabled, EAP-TTLS and PEAP authentication do not require a root certificate.
- **Client certificate:** You can install a client certificate. To be installed on the Wireless Network Printer Card, a client certificate must be in the form of PKCS #12 / Personal Information Exchange with a .pfx extension and be less than 3,072 bytes. EAP-TLS authentication needs a client certificate.
 - a Click **Configure**.
 - b If the client certificate has been configured, detailed information on the client certificate displays.
 - c Select the client certificate file.
 - d Upload the file and click **back** to return to the front page.

Making a certificate into a file using Windows Console

- 1 From the Windows **Start** menu, select **Run**.
- 2 Enter `mmc` in the Run dialogue box.
- 3 Select **File** → **Add/Remove Snap-in**.
- 4 Click **Add**, select **Certificate**, and then click **Add**.

- 5 In the Certificate Snap-in dialogue box, select **Computer Account** and click **Next** → **Finish** → **Close** → **OK**.
- 6 Select the certificate you want to change to a file.
- 7 When making a root certificate, select one of the certificates in the trusted root certificate authority folder.
- 8 When making a client certificate, select one of the certificates in the personal folder.
- 9 Right-click the certificate and select **All tasks** → **Export**.
- 10 In the Certificate Export wizard, click **Next**.
- 11 Select **DER encoded binary x.509 (.CER)** for a root certificate, or **PKCS #12 (.PFX)** for a client certificate, and click **Next**.
- 12 Enter a file name and click **Next**.
- 13 Click **Finish** to close the wizard.

Appendix H. Wireless Specifications

Items	Specifications	
Supported networks	<ul style="list-style-type: none"> • Windows 2000, XP 64 bit (Home & Pro), XP 32 bit (Home & Pro), Server 2003 & 2008, Vista 32bit / 64bit (Starter, Home Basic, Home Premium, Ultimate, Enterprise & Business), Windows 7, Server 2008 R2 • Various Linux OS including Red Hat 8.0 ~9.0, Fedora Core 1~4, Mandrake 9.2~10.1, and SuSE 8.2~9.2 • Mac OS 10.3 ~ 10.6 • NetWare 5.x, 6.x (TCP/IP Only) • Unix HP-UX, Solaris, SunOS, SCO UNIX" 	
Protocol	Standard TCP/IP printing, LPR, IPP	
Configuration utilities	SetIP, EWS (Embedded Web Service)	
Wireless interface	IEEE 802.11b/g standard	
Frequency band ¹	Americas	2.412 ~2.462GHz
	Europe	2.412 ~2.472GHz
	Asia-Pacific	2.412 ~2.472GHz
Spread spectrum method	802.11b mode	DSSS
	802.11g mode	OFDM
Data transfer rate	802.11b mode	11, 5.5, 2, 1Mbps
	802.11g mode ²	54, 48, 36, 24, 18, 12, 9, 6Mbps

1. Subject to local regulatory
2. 802.11g mode is supported only when connecting with IEEE 802.11g adapter

Appendix I. Regulatory statement

FCC Compliance

FCC Statement

This device complies with Part 15 of the FCC Rules. Operation is subject to the following two conditions: (1) this device may not cause harmful interference, and (2) this device must accept any interference received, including interference that may cause undesired operation.

Caution

Any changes or modifications NOT explicitly APPROVED by Samsung Electronics Co., Ltd. the responsible for compliance could cause the DELL5002 module to cease to comply with FCC rules part 15, and thus void the user's authority to operate the equipment.

RF-exposure statement

These modular transmitters, DELL5002, comply with FCC radiation exposure limits set forth for an uncontrolled environment. The DELL5002 should be installed and operated with minimum distance 20cm between the antenna and the body of the user or nearby persons.

The OEM integrator has to be aware not to provide information to the end user regarding how to install or remove this RF module in the user's manual of the end product which integrate this module.

This device is intended only for OEM integrators under the following conditions:

1) The antenna must be installed such that 20 cm is maintained between the antenna and users, and 2) The transmitter module may not be co-located with any other transmitter or antenna.

As long as the 2 conditions above are met, further transmitter testing will not be required. However, the OEM integrator is still responsible for testing their end product for any additional compliance requirements required with this module installed (for example, digital device emissions, PC peripheral requirements, etc.).

IMPORTANT NOTE: In the event that these conditions cannot be met (for example certain laptop configurations or co-location with another transmitter), then the FCC authorization is no longer considered valid and the FCC ID cannot be used on the final product. In these circumstances, the OEM integrator will be responsible for re-evaluating the end product (including the transmitter) and obtaining a separate FCC authorization.

Antenna

These modular transmitters are for OEM integrations only. The end-user product will be installed in such a manner that only the authorized antennas are used.

Label and manual requirements for the End Product

For an end product using the DELL5002 there must be a label containing, at least, the following information:

FCC ID for model DELL5002

This device contains

FCC ID: A3LDELL5002

The label must be affixed on an exterior surface of the end product such that it will be visible upon inspection in compliance with the modular approval guidelines developed by the FCC.

Where the DELL5002 will be installed in final products larger than 8cm x 10cm following statements has to be placed ONTO the device.

"This device complies with Part 15 of the FCC Rules.

Operation is subject to the following two conditions:

- (1) this device may not cause harmful interference, and
- (2) this device must accept any interference received, including interference that may cause undesired operation."

In case where the final product will be installed in locations where the end-consumer is not able to see the FCC ID and/or this statement, the FCC ID and the statement shall also be included in the end-product manual.

The user’s manual for end users must include the following information in a prominent location "IMPORTANT NOTE: To comply with FCC RF exposure compliance requirements, the antenna used for this transmitter must be installed to provide a separation distance of at least 20 cm from all persons and must not be co-located or operating in conjunction with any other antenna or transmitter."

EU Compliance

Regulatory compliance of the DELL5002

The DELL5002 are made for OEM integrations only. The European regulations applying to the DELL5002 is the R&TTE Directive 1999/5/EC.

DELL5002 meets the following requirements of the R&TTE Directive.

R&TTE Directive article	Test category	Harmonized standard
Article 3.1(a)	Protection of health and safety	EN 60950-1, EN 50385
Article 3.1(b)	EMC	EN 301 489-1/-17
Article 3.2	Effective use of the spectrum	EN 300 328

The conformity assessment for the DELL5002 were completed in accordance with the R&TTE Directive Annex IV procedures, and the EC Declaration of Conformity is attached to this manual.

Cautions regarding regulatory compliance when integrating the DELL5002

The person integrating the DELL5002 becomes the manufacturer of the final product and is therefore responsible for demonstrating compliance of the product with the essential requirements of the R&TTE Directive.

In all cases assessment of the final product must be made against the Essential requirements of the R&TTE Directive Article 3.1(a) and (b), safety and EMC respectively, and any relevant Article 3.3 requirements

This device is intended only for OEM integrators under the following conditions:

- 1 This appliance and its antenna must not be co-located or operating in conjunction with any other antenna or transmitter.

- 2 A minimum separation distance of 20 cm must be maintained between the antenna and the person for this appliance to satisfy the RF exposure requirements of the Council recommendation 1999/519/EC of 12 July 1999.

As long as the 2 conditions above are met, no further evaluation under Article 3.2 of the R&TTE Directive and do not require further involvement of an R&TTE Directive Notified Body for the final product. In all other cases, or if the manufacturer of the final product is in doubt then the equipment integrating the radio module must be assessed against Article 3.2 of the R&TTE Directive.

Please note that this product, DELL5002, uses radio frequency bands not harmonized throughout the Community. This product is classified as Class 2 radio equipment for which some Member States apply restrictions on placing on the market and in use. Any parties putting Class 2 radio equipment on the market must notify the relevant national spectrum management authority of their intention, and the radio equipment must be given a Class Identifier (alert symbol).

Antenna

This product, DELL5002, is for OEM integrations only. The end-user product will be installed in such a manner that only the authorized antennas are used.

Enclosure

This product, DELL5002, is made for integrating in another final product. For this reason, there are some parts of the final product on which the DELL5002 depends for regulatory compliance regarding EMC and safety. The DELL5002 is mounted on the circuit board of the final product, and must be contained inside the case of the final product. Integrated the DELL5002 in the final product so that its surfaces are not in contact with the outside.

Documentation

In the documentation for the conformity assessment of the final product, state clearly that the DELL5002 is integrated in the system.

Conformity Assessment of the Products integrating the DELL5002

The following is a supplementary explanation of conformity assessments for final products integrating the radio modules such as the DELL5002, that have passed conformity assessments in accordance with the R&TTE Directive.

The procedures for conformity assessment in accordance with the R&TTE Directive are the responsibility of the manufacturer of the final product. With final products integrating radio modules, the person who integrates the module in the system becomes the manufacturer of the final product, and it is their responsibility to certify that the requirements of the R&TTE Directive are met.

Exemption from conformity assessment

However, if radio modules that meet the requirements of the R&TTE Directive and that have passed the conformity assessment are integrated in a final product that follows the cautions concerning integrating radio modules, they are exempted from the conformity assessment for R&TTE Directive Article 3.2 (efficient use of the radio spectrum). For details, refer to the following Guidance and ETSI Technical Report from the R&TTE Compliance Association, and check whether your case applies.

Organization	R&TTE Compliance Association	Document No. TGN 01 Rev 3
Document title	Technical Guidance Note on Requirement for a Final Product that Integrates an R&TTE Directive Assessed Module	
URL	You can download the guidance from the download area of R&TTE Compliance association.	

Organization	ETSI (Technical report)	Document No. ETSI TR 102 070-2
Document title	Electromagnetic compatibility and Radio spectrum Matters (ERM); Guide to the application of harmonized standards to multi-radio and combined radio and non-radio equipment; Part 2: Effective use of radio frequency spectrum	
URL	You can download the guidance from the ETSI web site by entering TR102 070-2 in the search engine. Before downloading, you will be requested to register. http://www.rttca.com	

Conformity assessment procedures for final products exempted from R&TTE Directive Article 3.2

In every case, the manufacturer of a final product must follow the procedures for conformity assessment of the final product with the requirements of R&TTE Directive Article 3.1 (a) and (b), for safety and EMC. The conformity assessment for Article 3.2 is carried out in accordance with the following:

- 1) Attach the EN 300 328 test report of the assessed radio module and the EC Declaration of Conformity to the conformity assessment of the final product (The Declaration of Conformity is attached to the manual).
- 2) Specify on the conformity assessment of the end product that the assessed radio module was integrated in the system without any changes, in accordance with the installation directions of the manufacturer.

Notification of the final product

Please note that this product, DELL5002, uses radio frequency bands not harmonized throughout the Community. The notification required by R&TTE Directive Article 6(4) is necessary. It is the responsibility of the manufacturer of the final product to notify the relevant national spectrum management authority of the intention to place the final product on the market.

CE marking

It is necessary to attach the CE mark to the final product to indicate that it conforms with all the directives that apply to the final product. It must be given a Class Identifier (alert symbol) in addition to the CE mark.

Appendix J. OpenSSL License

Copyright (c) 1998-2001 The OpenSSL Project. All rights reserved.

Redistribution and use in source and binary forms, with or without modification, are permitted provided that the following conditions are met:

- 1 Redistributions of source code must retain the above copyright notice, this list of conditions and the following disclaimer.
- 2 Redistributions in binary form must reproduce the above copyright notice, this list of conditions and the following disclaimer in the documentation and/or other materials provided with the distribution.
- 3 All advertising materials mentioning features or use of this software must display the following acknowledgment: "This product includes software developed by the OpenSSL Project for use in the OpenSSL Toolkit. (<http://www.openssl.org/>)"
- 4 The names "OpenSSL Toolkit" and "OpenSSL Project" must not be used to endorse or promote products derived from this software without
- 5 prior written permission. For written permission, please contact openssl-core@openssl.org.
- 6 Products derived from this software may not be called "OpenSSL" nor may "OpenSSL" appear in their names without prior written permission of the OpenSSL Project.
- 7 Redistributions of any form whatsoever must retain the following acknowledgment: "This product includes software developed by the OpenSSL Project for use in the OpenSSL Toolkit (<http://www.openssl.org/>)"

THIS SOFTWARE IS PROVIDED BY THE OpenSSL PROJECT ``AS IS" AND ANY EXPRESSED OR IMPLIED WARRANTIES, INCLUDING, BUT NOT LIMITED TO, THE IMPLIED WARRANTIES OF MERCHANTABILITY AND FITNESS FOR A PARTICULAR PURPOSE ARE DISCLAIMED. IN NO EVENT SHALL THE OpenSSL PROJECT OR ITS CONTRIBUTORS BE LIABLE FOR ANY DIRECT, INDIRECT, INCIDENTAL, SPECIAL, EXEMPLARY, OR CONSEQUENTIAL DAMAGES (INCLUDING, BUT NOT LIMITED TO, PROCUREMENT OF SUBSTITUTE GOODS OR SERVICES; LOSS OF USE, DATA, OR PROFITS; OR BUSINESS INTERRUPTION) HOWEVER CAUSED AND ON ANY THEORY OF LIABILITY, WHETHER IN CONTRACT, STRICT LIABILITY, OR TORT (INCLUDING NEGLIGENCE OR OTHERWISE) ARISING IN ANY WAY OUT OF THE USE OF THIS SOFTWARE, EVEN IF ADVISED OF THE POSSIBILITY OF SUCH DAMAGE.

This product includes cryptographic software written by Eric Young (eay@cryptsoft.com). This product includes software written by Tim Hudson (tjh@cryptsoft.com).

Original SSLeay License

Copyright (C) 1995-1998 Eric Young (eay@cryptsoft.com) All rights reserved.

This package is an SSL implementation written by Eric Young (eay@cryptsoft.com). The implementation was written so as to conform to Netscapes SSL.

This library is free for commercial and non-commercial use as long as the following conditions are adhered to. The following conditions apply to all code found in this distribution, be it the RC4, RSA, lhash, DES, etc., code; not just the SSL code. The SSL documentation included with this distribution is covered by the same copyright terms except that the holder is Tim Hudson (tjh@cryptsoft.com). Copyright remains Eric Young's, and as such any Copyright notices in the code are not to be removed. If this package is used in a product, Eric Young should be given attribution as the author of the parts of the library used. This can be in the form of a textual message at program startup or in documentation (online or textual) provided with the package.

Redistribution and use in source and binary forms, with or without modification, are permitted provided that the following conditions are met:

- 1** Redistributions of source code must retain the copyright notice, this list of conditions and the following disclaimer.
- 2** Redistributions in binary form must reproduce the above copyright notice, this list of conditions and the following disclaimer in the documentation and/or other materials provided with the distribution.
- 3** All advertising materials mentioning features or use of this software must display the following acknowledgement: "This product includes cryptographic software written by Eric Young (eay@cryptsoft.com)" The word 'cryptographic' can be left out if the routines from the library being used are not cryptographic related:-).
- 4** If you include any Windows specific code (or a derivative thereof) from the apps directory (application code) you must include an acknowledgement: "This product includes software written by Tim Hudson (tjh@cryptsoft.com)"

THIS SOFTWARE IS PROVIDED BY ERIC YOUNG ``AS IS" AND ANY EXPRESS OR IMPLIED WARRANTIES, INCLUDING, BUT NOT LIMITED TO, THE IMPLIED WARRANTIES OF MERCHANTABILITY AND FITNESS FOR A PARTICULAR PURPOSE ARE DISCLAIMED. IN NO EVENT SHALL THE AUTHOR OR CONTRIBUTORS BE LIABLE FOR ANY DIRECT, INDIRECT, INCIDENTAL, SPECIAL, EXEMPLARY, OR CONSEQUENTIAL DAMAGES (INCLUDING, BUT NOT LIMITED TO, PROCUREMENT OF SUBSTITUTE GOODS OR SERVICES; LOSS OF USE, DATA, OR PROFITS; OR BUSINESS INTERRUPTION) HOWEVER CAUSED AND ON ANY THEORY OF LIABILITY, WHETHER IN CONTRACT, STRICT LIABILITY, OR TORT (INCLUDING NEGLIGENCE OR OTHERWISE) ARISING IN ANY WAY OUT OF THE USE OF THIS SOFTWARE, EVEN IF ADVISED OF THE POSSIBILITY OF SUCH DAMAGE.

The license and distribution terms for any publically available version or derivative of this code cannot be changed. i.e. this code cannot simply be copied and put under another distribution licence [including the GNU Public License.]

Index

B

Bonjour 43
BOOTP 23

C

Certificates
 client certificate 53
 making files 53
 root certificate 53
Channels 51
Client certificate
 installing 53

D

DDNS 26
DHCP 23

E

EtherTalk
 Bonjour 43
 configuring EtherTalk 40
 configuring the printer 41
 TCP/IP printing 42

F

Firmware upgrade 34

H

HTTP 23

I

IP filtering 34
IPP port 32

L

LPR port 31

N

NetWare
 adding a printer 39
 adding a queue 39
 Bindery configuration 38
 configuring Netware 37
 NDS configuration 38
 printing architecture 36

R

Resetting 11, 50, 51

Root certificate
installing 53

S

SLP 25

SNMP 24

Standard TCP/IP port 30

T

TCP/IP

in Macintosh 42

management protocol

BOOTP 23

DDNS 26

DHCP 23

HTTP 23

SLP 25

SNMP 24

UPnP 28

WINS 27

printing protocol

IPP port 32

LPR port 31

Standard TCP/IP port 30

U

UPnP 28

W

WINS 27

Wireless network

channels 51

frequency 51

operation mode 50

security settings 51

SSID 50